

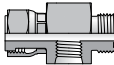

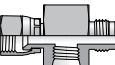

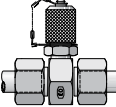













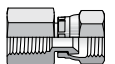

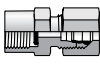

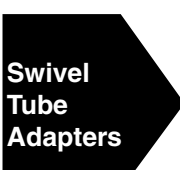
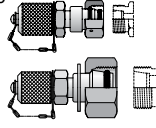
Diagnostic, Orifice, Bleed Adapters and Specialty Fittings

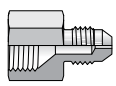
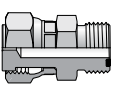
M

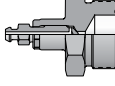
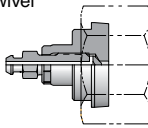
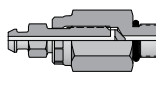
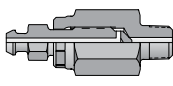
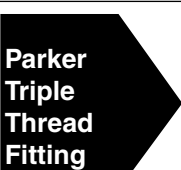
 <p>Diagnostic Tees</p>	<p>LOHL6G5TP ORFS Swivel / ORFS / SAE-ORB</p>  <p>M5</p>	<p>XHX6G5TP 37° Swivel / 37° Flare / SAE-ORB</p>  <p>M5</p>	<p>GMA3 EO Tube / EO Tube / EMA-3 Diagnostic Tip</p>  <p>M5</p>	 <p>Diagnostic Tee Port Adapters and Plugs</p>	<p>F50G SAE-ORB / NPTF</p>  <p>F13</p>
<p>P50N Hex Head Plug</p>  <p>F23</p>	<p>HP50N Hollow Hex Plug</p>  <p>F24</p>	 <p>NPT / SAE-ORB Pressure Gauge Adapters</p>	<p>G5L SAE-ORB Gauge / ORFS</p>  <p>M7</p>	<p>G65L SAE-ORB Gauge / ORFS Swivel</p>  <p>M7</p>	<p>GLO NPT Gauge / ORFS</p>  <p>M7</p>
<p>G6L NPT Gauge / ORFS Swivel</p>  <p>M7</p>	<p>GTX NPT Gauge / 37° Flare</p>  <p>M7</p>	<p>G6X NPT Gauge / 37° Swivel</p>  <p>M7</p>	 <p>BSP Pressure Gauge Adapters</p>	<p>MAVE BSPP Gauge / EO Swivel</p>  <p>M6</p>	<p>MAV BSPP Gauge / EO</p>  <p>M6</p>
<p>G4MXSMO BSPP Gauge / 37° Flare</p>  <p>M6</p>	<p>G4MLOSMO BSPP Gauge / ORFS</p>  <p>M6</p>	 <p>Swivel Tube Adapters</p>	<p>VKA3 EO Swivel / Diagnostic Tip</p>  <p>M8</p>	 <p>Orifice Fittings</p>	<p>XHX7 37° Seat / 37° Flare with Orifice</p>  <p>M9</p>
<p>LOHL6 ORFS Swivel with Orifice / ORFS</p>  <p>M9</p>	 <p>ORFS / Port Bleed Adapters</p>	<p>PNLOBA Bleed Screw / ORFS</p>  <p>M10</p>	<p>FNLBA Bleed Screw / ORFS Swivel</p>  <p>M10</p>	<p>P50NBA Bleed Screw / SAE-ORB</p>  <p>M10</p>	<p>HPBA Bleed Screw / NPT</p>  <p>M10</p>
 <p>Parker Triple Thread Fitting</p>	<p>0109 NPTF / PTT 30° Flare</p>  <p>M11</p>	 <p>Screen Fittings</p>	<p>Screen Fittings</p>  <p>M12</p>		

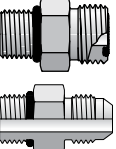
Introduction

Parker offers a line of specialty-type adapters specifically designed for diagnostic, fixed flow control and bleeding applications.

Diagnostic products consist of a line of in-line diagnostic tees, pressure gauge connectors and diagnostic tips. These products have been developed to work in conjunction with electronic diagnostic products available from Parker's Quick Coupling Division and other mechanical pressure and temperature sensing equipment. Some products can be used for fluid sampling and bleeding purposes as well.

Parker offers a standard and custom line of fixed flow control orifice fittings. These products are available as standard in two Parker product series — ORFS and 37° flare, and as a custom option in virtually any orifice size, fitting series, size, material and configuration.

Parker's bleed adapters are designed to remove entrapped air from a hydraulic system. A common problem in hydraulic systems is trapped air and the subsequent spillage of hydraulic oil while removing components to bleed air from lines under pressure. Parker's bleed adapters provide a quick, clean, and simple method of bleeding entrapped air from hydraulic systems.

Parker offers a limited line of PTT (Parker Triple Thread) 30° flare adapters for transportation markets. Lastly, Parker offers a line of screen fittings as a final measure of protection.

Diagnostic Fittings and Adapters

In-Line Diagnostic Tees

Features

- Designed around the two most common hydraulic tube/hose interfaces: ORFS (Seal-Lok) and 37° flare (JIC / Triple-Lok) (see A)
- ORFS and 37° flare swivel feature offers unlimited positioning without displacing port adapter (see B)
- Uses elastomeric sealing: SAE -4 (7/16-20 UNF) port as universal diagnostic port per SAE J1926-1 / ISO 11926 (see C)
- Enlarged and lengthened body hex ensures that diagnostic port offers full thread engagement and pressure capability (see D)
- Adaptable to Parker's line of diagnostic and fluid sampling tips including: EMA3, PD and PDFS, as well as various direct connecting electronic/mechanical pressure gauges*
- Designed to complement Parker's line of Senso-Control® electronic diagnostic equipment

*Diagnostic and sampling tips EMA3, PD and PDFS series are available from Parker's Quick Coupling Division (tel. 763-544-7781 and/or www.parker.com/quickcouplings)



Fig. M1 — Parker offers a full line of diagnostic, orifice, bleed adapters and specialty fittings

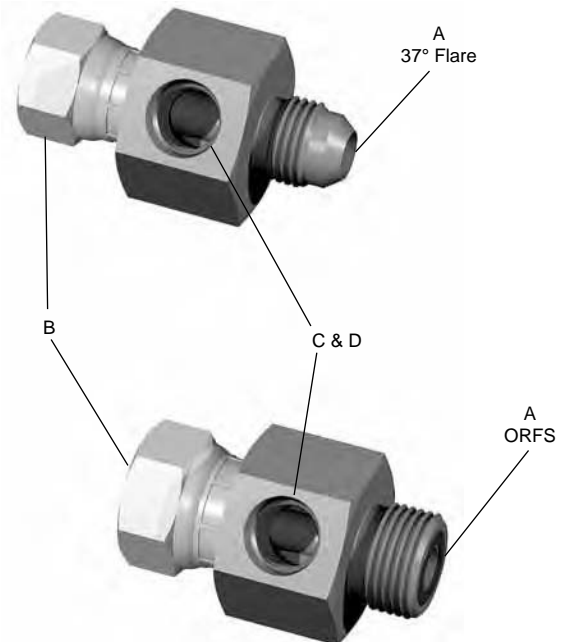

Fig. M2 — Parker's XHX6G5TP (top) and LOHL6G5TP (bottom) in-line diagnostic tees

Applications

- In-line pressure and temperature measurements
- In-line oil sampling to evaluate hydraulic contamination, caused by problems with filtration or internal components
- In-field diagnostics without removal of port adapters. Simply remove hose swivel and insert in-line tee.
- Permanent or temporary OEM and MRO diagnostic applications:
 - Where traditional in-port diagnostic tips cannot be located or easily accessed
 - Where OEM diagnostic tips have not been installed
 - Non-traditional diagnostic locations (portable)
 - Where port threads are not compatible with standard diagnostic tips
- To eliminate reducer bushings and couplings typically required to neck down from larger size connections to smaller connections; e.g. reductions required for a gauge, diagnostic tip, bleed adapter, or tube/hose connection.

Assembly Instructions

The body of the diagnostic tee can be used repeatedly for 10-20 remakes at full rated pressure and assembly torque. See Tables M1 and M2 for recommended swivel nut assembly torques.

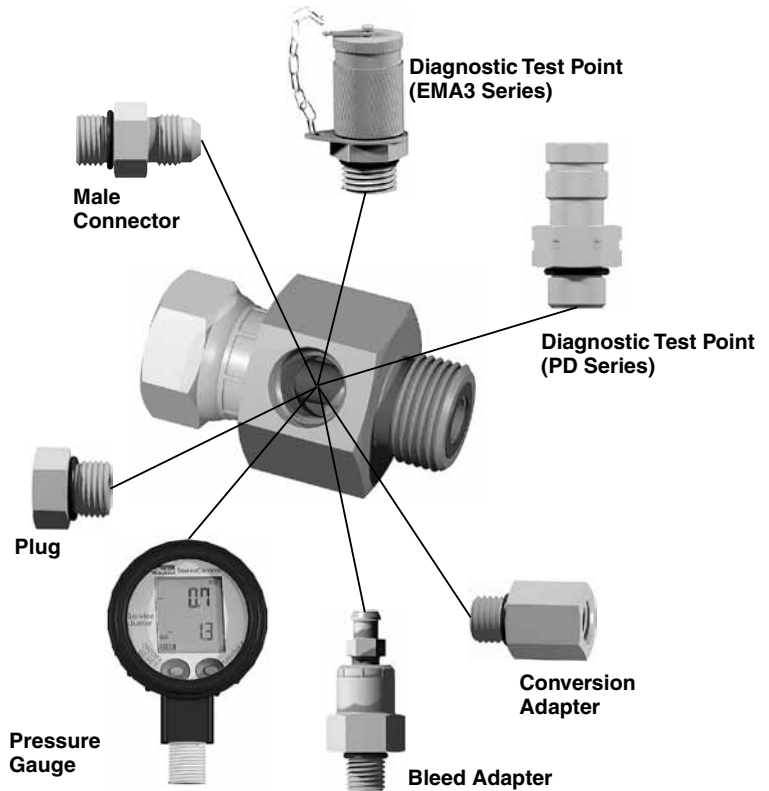

Fig. M3 — Illustration showing the versatility of Parker's diagnostic tee product line

Part Number	Assembly Torque (+10%-0)	
	in.-lb.	ft.-lb.
4-4 XHX6G5TP	130	11
6-4 XHX6G5TP	235	20
8-4 XHX6G5TP	525	43
10-4 XHX6G5TP	—	55
12-4 XHX6G5TP	—	80
16-4 XHX6G5TP	—	115
20-4 XHX6G5TP	—	160
24-4 XHX6G5TP	—	185

Note: Assembly values are for dry, unlubricated swivel nut connections

Table M1 — Assembly Torques (Swivel nut) for Diagnostic Tees

Part Number	Assembly Torque (+10%-0)	
	in.-lb.	ft.-lb.
4-4 LHL6G5TP	220	18
6-4 LHL6G5TP	360	30
8-4 LHL6G5TP	480	40
10-4 LHL6G5TP	—	60
12-4 LHL6G5TP	—	85
14-4 LHL6G5TP	—	100
16-4 LHL6G5TP	—	110
20-4 LHL6G5TP	—	150
24-4 LHL6G5TP	—	230
32-4 LHL6G5TP	—	360

Table M2 — Assembly Torques (Swivel nut) for Diagnostic Tees

Dimensions and pressures for reference only, subject to change.

LOHL6G5TP

Gauge Port Tee
ORFS / ORFS Swivel /
SAE-ORB

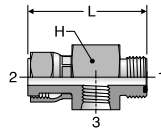

XHX6G5TP

Gauge Port Tee
37° Flare / 37° Swivel /
SAE-ORB

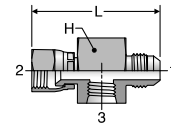

TUBE FITTING PART #	END SIZE			H (in.)	L (in.)	Pressure (x 1,000 PSI)	
	1 (in.)	2 (in.)	3 UN/UNF			Static -S	Dynamic -S
4-4 LOHL6G5TP	1/4	1/4	7/16-20	1-1/16	1.83	10.0	6.0
6-4 LOHL6G5TP	3/8	3/8	7/16-20	1-1/16	1.95	10.0	6.0
8-4 LOHL6G5TP	1/2	1/2	7/16-20	1-1/16	2.18	10.0	6.0
10-4 LOHL6G5TP	5/8	5/8	7/16-20	1-1/8	2.40	10.0	6.0
12-4 LOHL6G5TP	3/4	3/4	7/16-20	1-1/4	2.59	10.0	6.0
16-4 LOHL6G5TP	1	1	7/16-20	1-1/2	2.85	9.5	6.0
20-4 LOHL6G5TP	1 1/4	1 1/4	7/16-20	1-3/4	3.07	6.5	5.0
24-4 LOHL6G5TP	1 1/2	1 1/2	7/16-20	2-1/8	3.22	5.0	4.0

TUBE FITTING PART #	END SIZE			H (in.)	L (in.)	Pressure (x 1,000 PSI)	
	1 (in.)	2 (in.)	3 UN/UNF			Static -S	Dynamic -S
4-4 XHX6G5TP	1/4	1/4	7/16-20	1-1/16	1.99	10.0	6.0
6-4 XHX6G5TP	3/8	3/8	7/16-20	1-1/16	2.08	6.5	5.0
8-4 XHX6G5TP	1/2	1/2	7/16-20	1-1/16	2.30	6.5	5.0
10-4 XHX6G5TP	5/8	5/8	7/16-20	1-1/8	2.49	6.5	5.0
12-4 XHX6G5TP	3/4	3/4	7/16-20	1-1/4	2.66	6.5	5.0
16-4 XHX6G5TP	1	1	7/16-20	1-1/2	2.99	6.0	4.5
20-4 XHX6G5TP	1 1/4	1 1/4	7/16-20	1-3/4	3.33	6.0	4.5
24-4 XHX6G5TP	1 1/2	1 1/2	7/16-20	2	3.71	5.5	4.0

Note: Fluorocarbon O-rings are available upon request.

GMA3

Diagnostic Tip
EO Tube / EO Tube /
M16 x 2.0 Integrated Tip

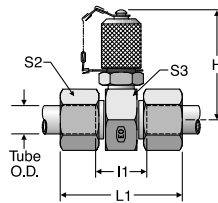

TUBE FITTING PART #	END SIZE (mm)	H (mm)	I1 (mm)	L1 (mm)	S2 (mm)	S3 (mm)	Pressure (x 1,000 PSI)	
							Static CF	Dynamic CF
GMA3/06L	6	49	21	51	14	24	7.2	4.5
GMA3/08L	8	49	21	51	17	24	7.2	4.5
GMA3/10L	10	49	23	53	19	24	7.2	4.5
GMA3/12L	12	50	23	53	22	27	5.8	4.5
GMA3/15L	15	52	25	55	27	30	5.8	4.5
GMA3/18L	18	53	24	57	32	32	5.8	4.5
GMA3/22L	22	55	28	61	36	36	3.6	2.3
GMA3/28L	28	57	28	61	41	41	3.6	2.3
GMA3/35L	35	60	26	69	50	46	3.6	2.3
GMA3/42L	42	64	25	71	60	55	3.6	2.3
GMA3/06S	6	49	25	55	17	24	10.1	9.1
GMA3/08S	8	49	25	55	19	24	10.1	9.1
GMA3/10S	10	49	24	57	22	24	10.1	9.1
GMA3/12S	12	49	24	57	24	24	10.1	9.1
GMA3/14S	14	50	27	63	27	27	10.1	9.1
GMA3/16S	16	52	26	63	30	30	9.1	5.8
GMA3/20S	20	55	26	69	36	36	9.1	5.8
GMA3/25S	25	57	27	75	46	41	9.1	5.8
GMA3/30S	30	60	28	81	50	46	6.1	5.8
GMA3/38S	38	64	29	91	60	55	6.1	4.5

To specify EO-2, add "Z" between tube size and series.
Example: GMA3/28ZLA3C

Dimensions and pressures for reference only, subject to change.



BSPP Diagnostic Pressure Gauge Adapters

Parker's BSPP direct-connect pressure gauge adapters are available in the most common tube/hose connections — ORFS, 37° Flare (JIC) and 24° Metric Flareless (DIN 2353). European pressure gauges often utilize BSPP threads on the pressure gauges (manometers). Sealing is achieved at the bottom of the port with a sealing washer as shown in the illustration on the right.

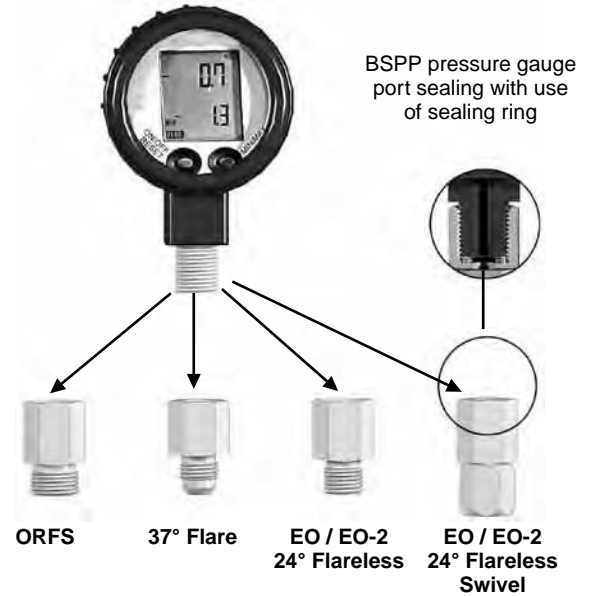

BSPP Pressure Gauge Adapters

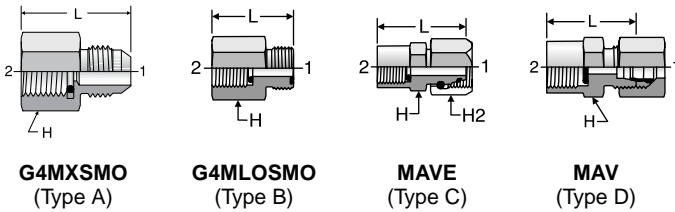

Fig. M4 — BSPP pressure gauge connections

TUBE FITTING PART #	TYPE	END SIZE		L (mm)	H BODY HEX (mm)	H2 NUT HEX (mm)	Pressure (x 1,000 PSI)	
		1 (in.)	2 BSPP				Static S	Dynamic S
4-4G4MXSMO	A	1/4	1/4-19	31.0	17	—	5.0	5.0
6G4MXSMO	A	3/8	1/4-19	28.0	17	—	5.0	5.0
8-4G4MXSMO	A	1/2	1/4-19	31.0	19	—	5.0	5.0
4-4G4MLOSMO	B	1/4	1/4-19	26.8	17	—	5.0	5.0
6G4MLOSMO	B	3/8	1/4-19	28.2	19	—	5.0	5.0
8-4G4MLOSMO	B	1/2	1/4-19	29.8	22	—	5.0	5.0
		1 (mm)	2 BSPP				Static CF	Dynamic CF
MAVE06LR	C	6	1/4-19	35.5	19	14	4.6	4.6
MAVE08LR	C	8	1/4-19	35.5	19	17	4.6	4.6
MAVE10LR	C	10	1/4-19	36.0	19	19	4.6	4.6
MAVE06SR	C	6	1/2-14	42.5	27	17	9.1	9.1
MAVE08SR	C	8	1/2-14	43.0	27	19	9.1	9.1
MAVE10SR	C	10	1/2-14	43.5	27	22	9.1	9.1
MAVE12SR	C	12	1/2-14	45.0	27	24	9.1	9.1
MAVE06SR1/4	C	6	1/4-19	35.5	19	17	9.1	9.1
MAVE08SR1/4	C	8	1/4-19	35.5	19	19	9.1	9.1
MAVE10SR1/4	C	10	1/4-19	39.0	19	22	9.1	9.1
MAVE12SR1/4	C	12	1/4-19	39.0	19	24	9.1	9.1
MAV04LLR	D	4	1/4-19	33.0	19	10	1.4	1.4
MAV06LR	D	6	1/4-19	37.0	19	14	4.5	4.5
MAV08LR	D	8	1/4-19	37.0	19	17	4.5	4.5
MAV10LR	D	10	1/4-19	38.0	19	19	4.5	4.5
MAV12LR	D	12	1/4-19	38.0	19	22	4.5	4.5
MAV06SR	D	6	1/2-14	46.0	27	17	9.1	9.1
MAV08SR	D	8	1/2-14	46.0	27	19	9.1	9.1
MAV10SR	D	10	1/2-14	47.0	27	22	9.1	9.1
MAV12SR	D	12	1/2-14	47.0	27	24	9.1	9.1

Note: MAV supplied as standard with PSR +M nut (EO assembled)

* BSPP Pressure Gauge Connection requires seal. 1/4" replacement seal P/N: M25180.

** BSPP Pressure Gauge Connection requires seal. 1/4" replacement seal P/N: DK11/4CFX, 1/2" replacement seal P/N: DK11/2CFX.

Dimensions and pressures for reference only, subject to change.



NPT and SAE-ORB Diagnostic Pressure Gauge Adapters

Parker's NPT and SAE-ORB direct-connect pressure gauge adapters are available in the most common North American tube/hose connections — ORFS and 37° Flare (JIC). North American pressure gauge manufacturers offer gauges primarily with NPT and some with SAE-ORB port stud options. These 37° flare and ORFS connectors are designed to attach pressure gauges to hose swivel ends or directly to run / branch tees for in-line diagnostic applications as shown on the right.

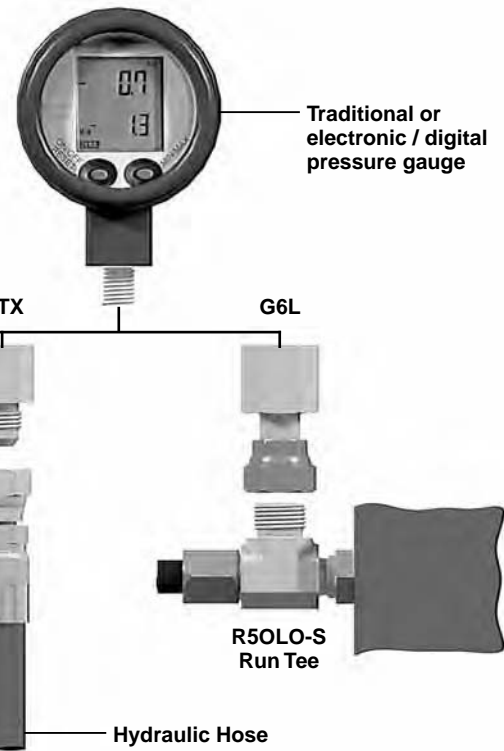

NPT / SAE Pressure Gauge Adapters

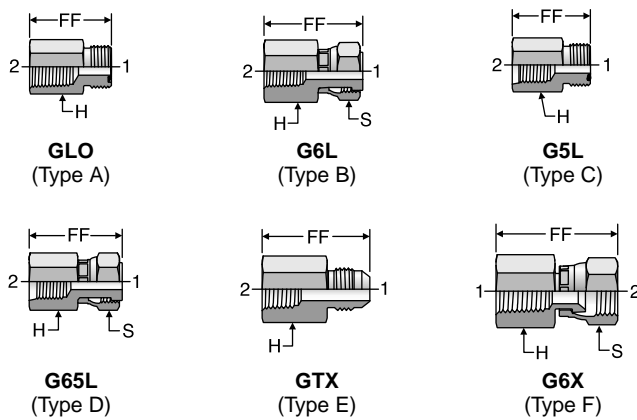

Fig. M5 — Typical applications for NPT pressure gauge adapters. Illustrations show direct hose connections and Run Tee connection.

TUBE FITTING PART #	TYPE	END SIZE		FF (in.)	H BODY HEX (in.)	S SWIVEL NUT HEX (in.)	Pressure (x 1,000 PSI)	
		1 (in.)	2 NPT				Static -S	Dynamic -S
		4-4 GLO	A				1/4	1/4-18
6 GLO	A	3/8	1/4-18	1.30	3/4	—	8.0	6.0
8-4 GLO	A	1/2	1/4-18	1.20	7/8	—	9.5	6.0
4-4 G6L	B	1/4	1/4-18	1.48	3/4	11/16	9.5	6.0
6 G6L	B	3/8	1/4-18	1.60	7/8	13/16	8.0	6.0
8-4 G6L	B	1/2	1/4-18	1.75	7/8	15/16	9.5	6.0
		UN/UNF						
4 G5LO	C	1/4	7/16-20	1.10	3/4	—	6.0	5.0
6-4 G5LO	C	3/8	7/16-20	1.08	3/4	—	6.0	5.0
8-4 G5LO	C	1/2	7/16-20	0.78	7/8	—	6.0	5.0
4 G65L	D	1/4	7/16-20	1.38	11/16	11/16	6.0	5.0
6-4 G65L	D	3/8	7/16-20	1.51	3/4	13/16	6.0	5.0
8-4 G65L	D	1/2	7/16-20	1.57	7/8	15/16	6.0	5.0
		NPT						
2 GTX	E	1/8	1/8-27	1.13	9/16	—	10.0	5.0
3 GTX	E	3/16	1/8-27	1.13	9/16	—	10.0	5.0
4-4 GTX	E	1/4	1/4-18	1.39	3/4	—	10.0	5.0
4 GTX	E	1/4	1/8-27	1.19	9/16	—	10.0	5.0
6-2 GTX	E	3/8	1/8-27	1.13	5/8	—	10.0	5.0
6 GTX	E	3/8	1/4-18	1.41	3/4	—	10.0	5.0
8-4 GTX	E	1/2	1/4-18	1.41	13/16	—	8.0	5.0
4-4 G6X	F	1/4	1/4-18	9/16	3/4	9/16	9.5	6.0
4 G6X	F	1/4	1/8-27	9/16	9/16	9/16	10.0	7.5
6 G6X	F	3/8	1/4-18	11/16	3/4	11/16	6.0	5.0

Dimensions and pressures for reference only, subject to change.

EO Diagnostic Swivels

EO Diagnostic Swivels are commonly used on EO tees (24° flareless - DIN 2353) where periodic pressure and temperature checks are required. The M16 x 2 diagnostic tip mates with the SMA3 diagnostic nose offered by Parker's Quick Coupling Division.

VKA3 M16 x 2.0 Diagnostic Tip / EO Swivel

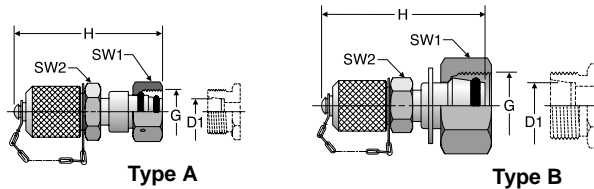

TUBE FITTING PART # STEEL	TYPE	D1 TUBE O.D. (mm)	G Metric	H REF. (mm)	SW1 (mm)	SW2 (mm)	Pressure (x 1,000 PSI)	
							Static	Dynamic
							CF	CF
VKA3/06L	A	6	M12 x 1.5	55	17	17	7.2	4.5
VKA3/08L	A	8	M14 x 1.5	51	17	17	7.2	4.5
VKA3/10L	A	10	M16 x 1.5	53	17	19	7.2	4.5
VKA3/12L	A	12	M18 x 1.5	53	17	22	5.8	4.5
VKA3/15L	B	15	M22 x 1.5	59	17	27	5.8	4.5
VKA3/18L	B	18	M26 x 1.5	59	17	32	5.8	4.5
VKA3/22L	B	22	M30 x 2	60	17	39	3.6	2.3
VKA3/28L	B	28	M36 x 2	64	17	41	3.6	2.3
VKA3/35L	B	35	M45 x 2	71	17	50	3.6	2.3
VKA3/42L	B	42	M52 x 2	72	17	60	3.6	2.3
VKA3/06S	A	6	M14 x 1.5	50	17	17	10.1	9.1
VKA3/08S	A	8	M16 x 1.5	52	17	19	10.1	9.1
VKA3/10S	A	10	M18 x 1.5	53	17	22	10.1	9.1
VKA3/12S	A	12	M20 x 1.5	54	19	24	10.1	9.1
VKA3/14S	B	14	M22 x 1.5	59	17	27	10.1	9.1
VKA3/16S	B	16	M24 x 1.5	58	17	30	9.1	5.8
VKA3/20S	B	20	M30 x 2	65	17	36	9.1	5.8
VKA3/25S	B	25	M36 x 2	68	17	46	9.1	5.8
VKA3/30S	B	30	M42 x 2	74	17	50	6.0	5.8
VKA3/38S	B	38	M52 x 2	81	17	60	6.0	4.5

Dimensions and pressures for reference only, subject to change.

Orifice Fittings

These compact and cost effective orifice adapters allow OEMs to pre-set, at the factory, a specified orifice in specific hydraulic tube or hose lines. Costly flow control valves can be eliminated or minimized in a system by selecting the proper orifice sizes at the factory. OEMs can also be assured that end users are not adjusting the factory established flow and speed characteristics of the hydraulic system.

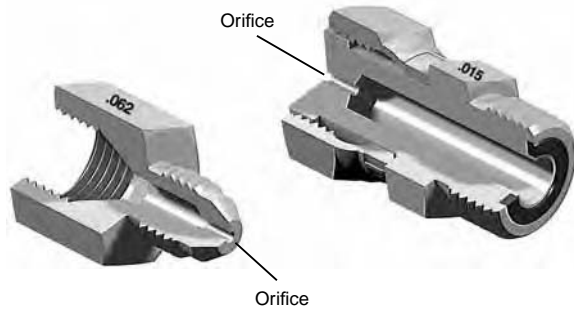

XHX7 Orifice

In-Line Orifice Connector
37° Flare / Female 37° Seat

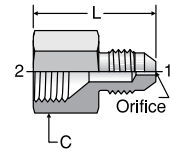

TUBE FITTING PART #	END SIZE 1 & 2 (in.)	C HEX (in.)	ORIFICE (in.)	L (in.)	Pressure (x 1,000 PSI)	
					Static -S	Dynamic -S
4 XHX7-S .015 Orifice	1/4	9/16	.015	1.10	10.0	5.0
4 XHX7-S .031 Orifice	1/4	9/16	.031	1.10	10.0	5.0
4 XHX7-S .047 Orifice	1/4	9/16	.047	1.10	10.0	5.0
4 XHX7-S .062 Orifice	1/4	9/16	.062	1.10	10.0	5.0
4 XHX7-S .078 Orifice	1/4	9/16	.078	1.10	10.0	5.0
4 XHX7-S .094 Orifice	1/4	9/16	.094	1.10	10.0	5.0
6 XHX7-S .015 Orifice	3/8	11/16	.015	1.18	10.0	5.0
6 XHX7-S .031 Orifice	3/8	11/16	.031	1.18	10.0	5.0
6 XHX7-S .047 Orifice	3/8	11/16	.047	1.18	10.0	5.0
6 XHX7-S .062 Orifice	3/8	11/16	.062	1.18	10.0	5.0
6 XHX7-S .078 Orifice	3/8	11/16	.078	1.18	10.0	5.0
6 XHX7-S .094 Orifice	3/8	11/16	.094	1.18	10.0	5.0
8 XHX7-S .015 Orifice	1/2	7/8	.015	1.32	8.5	5.0
8 XHX7-S .031 Orifice	1/2	7/8	.031	1.32	8.5	5.0
8 XHX7-S .047 Orifice	1/2	7/8	.047	1.32	8.5	5.0
8 XHX7-S .062 Orifice	1/2	7/8	.062	1.32	8.5	5.0
8 XHX7-S .078 Orifice	1/2	7/8	.078	1.32	8.5	5.0
8 XHX7-S .094 Orifice	1/2	7/8	.094	1.32	8.5	5.0

The Parker Advantage

- 37° flare and ORFS configurations as standard
- Three standard body sizes available: 1/4" 3/8", and 1/2"
- Available in commonly accepted pre-set orifice sizes as shown on accompanying tables
- Designed for permanent or temporary installation
- Can be installed in-line into hydraulic system by simply connecting between hose swivel and adapter
- Orifice size is permanently stamped on body
- Can eliminate costly flow control valves

Applications:

- Fixed rotation speed for hydraulic motors
- Fixed speed on cylinder extend or retract

Direct Port Orifice Fittings:

Available as a custom product, Parker also offers a line of orifice adapters that will replace a traditional port adapter.

LOHL6 Orifice

In-Line Orifice Connector
ORFS Swivel / ORFS

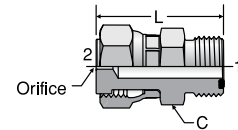

TUBE FITTING PART #	END SIZE 1 & 2 (in.)	C HEX (in.)	ORIFICE (in.)	L (in.)	Pressure (x 1,000 PSI)	
					Static -S	Dynamic -S
4 LOHL6-S .015 Orifice	1/4	5/8	.015	1.33	12.0	9.2
4 LOHL6-S .031 Orifice	1/4	5/8	.031	1.33	12.0	9.2
4 LOHL6-S .047 Orifice	1/4	5/8	.047	1.33	12.0	9.2
4 LOHL6-S .062 Orifice	1/4	5/8	.062	1.33	12.0	9.2
4 LOHL6-S .078 Orifice	1/4	5/8	.078	1.33	12.0	9.2
4 LOHL6-S .094 Orifice	1/4	5/8	.094	1.33	12.0	9.2
6 LOHL6-S .015 Orifice	3/8	3/4	.015	1.44	12.0	9.2
6 LOHL6-S .031 Orifice	3/8	3/4	.031	1.44	12.0	9.2
6 LOHL6-S .047 Orifice	3/8	3/4	.047	1.44	12.0	9.2
6 LOHL6-S .062 Orifice	3/8	3/4	.062	1.44	12.0	9.2
6 LOHL6-S .078 Orifice	3/8	3/4	.078	1.44	12.0	9.2
6 LOHL6-S .094 Orifice	3/8	3/4	.094	1.44	12.0	9.2
8 LOHL6-S .015 Orifice	1/2	7/8	.015	1.67	12.0	9.2
8 LOHL6-S .031 Orifice	1/2	7/8	.031	1.67	12.0	9.2
8 LOHL6-S .047 Orifice	1/2	7/8	.047	1.67	12.0	9.2
8 LOHL6-S .062 Orifice	1/2	7/8	.062	1.67	12.0	9.2
8 LOHL6-S .078 Orifice	1/2	7/8	.078	1.67	12.0	9.2
8 LOHL6-S .094 Orifice	1/2	7/8	.094	1.67	12.0	9.2

Dimensions and pressures for reference only, subject to change.

Bleed Adapters

Entrapped air is a major contributor to inefficient operation. Typically, bleeding hydraulic systems is done by “cracking” a connection to “bleed off” the entrapped air. This practice is not recommended, especially in larger size fittings where high forces can exist. Parker’s bleed adapters are especially beneficial in applications where elastomeric seals (O-rings) can be extruded and/or damaged during bleeding such as with Parker’s Seal-Lok fittings.

Parker’s bleed adapters are designed specifically for installation directly to ORFS (O-Ring Face Seal) type fittings or into SAE/NPT manifolds and valves where bleeding is often required.

Product Characteristics

- Bleed hydraulic systems without “cracking” hydraulic connections
- Uses standard automotive bleed screw design
- Bleed screw is permanently crimped into body housing, for blowout prevention
- In-port options with SAE and NPT male studs
- Tube/hose connection options to male and female ORFS

ORFS Bleed Adapters

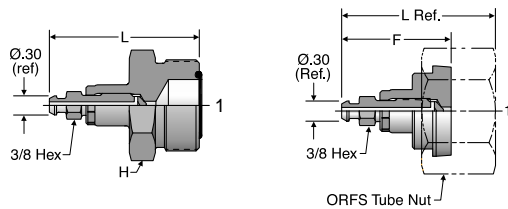

PNLOBA

FNLBA

ORFS Tube Nut sold separately

TUBE FITTING PART #	END SIZE 1 (in.)	F (in.)	H (in.)	L (in.)	Pressure (x 1,000 PSI)	
					Static -S	Dynamic -S
4 PNLOBA	1/4	-	11/16	1.90	12.0	9.2
6 PNLOBA	3/8	-	3/4	1.97	12.0	9.2
8 PNLOBA	1/2	-	7/8	2.07	12.0	9.2
10 PNLOBA	5/8	-	1 1/16	2.19	11.0	6.0
12 PNLOBA	3/4	-	1 1/4	2.27	11.0	6.0
16 PNLOBA	1	-	1 1/2	2.35	9.5	6.0
20 PNLOBA	1 1/4	-	1 3/4	2.41	8.0	6.0
24 PNLOBA	1 1/2	-	2 1/8	2.48	6.5	5.0
8 FNLBA	1/2	1.63	15/16	2.07	12.0	9.2
10 FNLBA	5/8	1.63	1 1/8	2.17	11.0	6.0
12 FNLBA	3/4	1.63	1 3/8	2.21	11.0	6.0
16 FNLBA	1	1.63	1 5/8	2.21	9.5	6.0
20 FNLBA	1 1/4	1.63	1 7/8	2.21	8.0	6.0
24 FNLBA	1 1/2	1.63	2 1/4	2.21	6.5	5.0

Bleeding Hydraulic Systems with Parker Bleed Adapters

Whenever possible, the bleed adapter should be mounted at the highest point within the hydraulic system. The trapped air can be relieved while the system is running at low pressure. To bleed, loosen the bleed screw 1/2 turn counterclockwise. After the hydraulic fluid begins to run freely from the bleed screw, the bleed screw should be re-tightened.

Bleed Screw Tightening Torque: 35-40 in.-lbs.

Warning: When bleeding hydraulic fluid, operate the system below 500 psi. To avoid injury, ensure that all persons are clear of the path of discharge. Another recommended practice is to attach a section of hose over the bleed screw/adapter to direct oil away from the area and to reduce oil spillage.

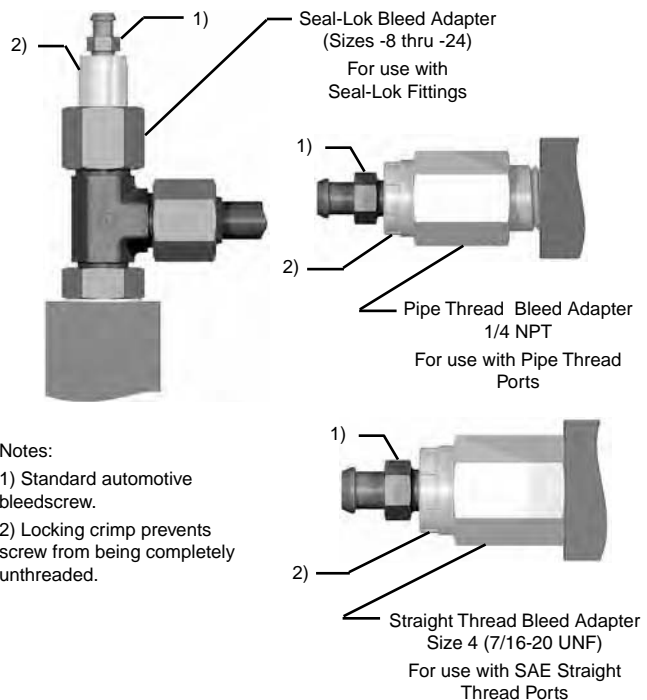

Notes:

- 1) Standard automotive bleedscrew.
- 2) Locking crimp prevents screw from being completely unthreaded.

Port Bleed Adapters



4 P5ONBA

1/4 HPBA

TUBE FITTING PART #	END SIZE 1	BODY HEX (in.)	H (in.)	L REF. (in.)	LL REF. (in.)	Pressure (x 1,000 PSI)	
						Static -S	Dynamic -S
4 P5ONBA	7/16-20 UN/UNF-2A	11/16	11/16	2.05	1.62	10.0	6.0
1/4 HPBA	1/4-18 NPTF	11/16	11/16	2.20	1.86	10.0	6.0

Dimensions and pressures for reference only, subject to change.



Parker Triple Thread (PTT) Adapters

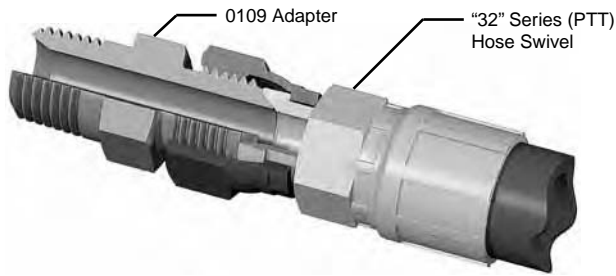

Parker Triple Thread (PTT) adapters are considered the original three-piece hydraulic flared fittings. As an improved fitting design over traditional two-piece flared fittings. Its use was widespread as a primary hydraulic connection for various aircraft, industrial and mobile applications. The PTT 30° flare three-piece design paved the progress towards the standardized 37° connection (through the Joint Industrial Council – JIC) and later to current standardization initiatives of SAE and ISO. Its popularity has been diminished by the more common and standardized 37° flare connection, but even today certain transportation customers utilize PTT hose adapters for OEM and MRO applications.

Applications:

- Diesel engine manufacturers
- Transportation air conditioning lines

0109

Parker Triple Thread Fitting
NPTF / PTT

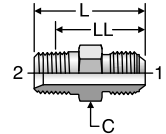

Mates with 32 style hose fittings.

TUBE FITTING PART #	END SIZE		C HEX (in.)	L (in.)	LL AFTER ASSY (in.)	Dynamic Pressure (x 1,000 PSI)		
	1 (in.)	2 NPTF				-S	-SS	-B
0109-12-16	1 (1 5/16-14)	3/4-14	1 3/8	1.84	1.36	3.0		
0109-16-16	1 (1 5/16-14)	1-11 1/2	1 3/8	2.03	1.46	3.0		
0109-20-20	1 1/4 (1 5/8-14)	1 1/4-11 1/2	1 3/4	2.22	1.63	3.0		
0109-24-24	1 1/2 (1 7/8-14)	1 1/2-11 1/2	2	2.50	1.91	3.0		

Dimensions and pressures for reference only, subject to change.

Screen Fittings

Introduction

Parker screen fittings ensure the final measure of protection against particles that find their way into a system (even a properly filtrated one) during installation, maintenance, failure of components or by other means. Screen fittings provide a vital safeguard for critical components against damage due to contamination. They are intended to work in conjunction with a good filtration system and are available with screens that retain particle sizes from 480 to 65 micron.

Parker screen fittings are ideal for protecting:

- Gauges and instrumentation
- Critical hydraulic components such as pump compensator load sensing controls, proportional valves, relief valves, etc.
- Precision orifices from clogging
- Expensive components in test bench circuits (against particle contamination created by failed components)

Design and Construction

Fitting Body. Parker screen fittings utilize standard Seal-Lok O-ring face seal and Triple-Lok 37° fitting bodies located in Section B and C respectively in this catalog. (Refer to the "How to Order" paragraph, later in this section, for a listing of configurations for screen fittings that are offered as standard). All screen fittings are manufactured with the micron rating stamped on the fitting body.

Screen. Screen fittings are constructed with stainless-steel screen elements. Sizes -6 through -12 fittings are manufactured with a dome-style screen, while size -4 fittings are made with a basket-style screen (see Fig. M7 and M8). Table M3 displays the various micron ratings for available screens. Additionally, Parker screen fittings have bi-directional flow capacity and can be installed in either the tube or port end of the fitting.

To prevent build up of debris, screens must be replaced or cleaned when filters are replaced or during flushing of hydraulic system.

Square Mesh Number	Nominal Micron Rating
40	480*
60	320*
80	230
100	165*
150	125
200	100
325	65

Table M3 — Micron Ratings for available screens

**These micron ratings are not available as standard from stock*

Pressure Ratings

Parker screen fittings have the same dynamic pressure ratings as the equivalent fitting body (without the screen). Refer to sections A and B for the pressure ratings for Seal-Lok O-ring face seal and Triple-Lok 37° flare fittings.

How to Order:

Please call the Tube Fittings Division for part number and ordering - 614-279-7070.



Fig. M6 — Screen Fittings.



Fig. M7 — Six dome-style screens and one basket-style screen.



Fig. M8 — Fitting cutaway with dome-style screen.

Dimensions and pressures for reference only, subject to change.

Pressure Drop

All screen fittings have been tested to determine the maximum pressure drop and screen retention. The following "Pressure Drop vs. Flow" charts were derived from actual test data and may be used as a guide in determining pressure drop at various flow rates through screen fittings for the fluid indicated.

4 F50X Screen Adapter Pressure Drop vs. Flow

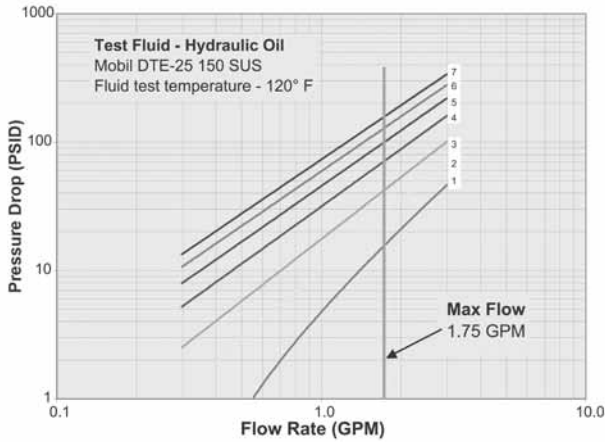

6 F50X Screen Adapter Pressure Drop vs. Flow

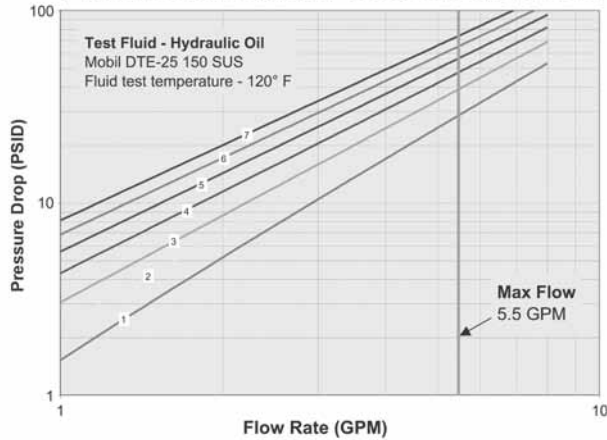

8 F50X Screen Adapter Pressure Drop vs. Flow

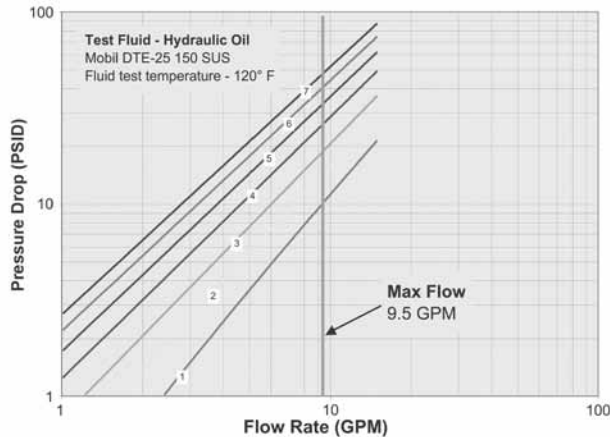

10 F50X Screen Adapter Pressure Drop vs. Flow

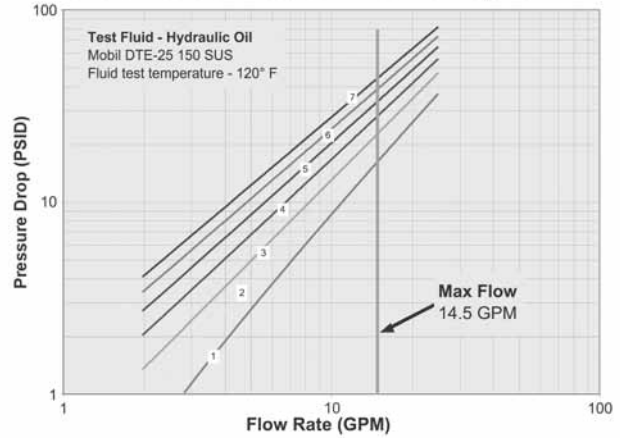

12 F50X Screen Adapter Pressure Drop vs. Flow

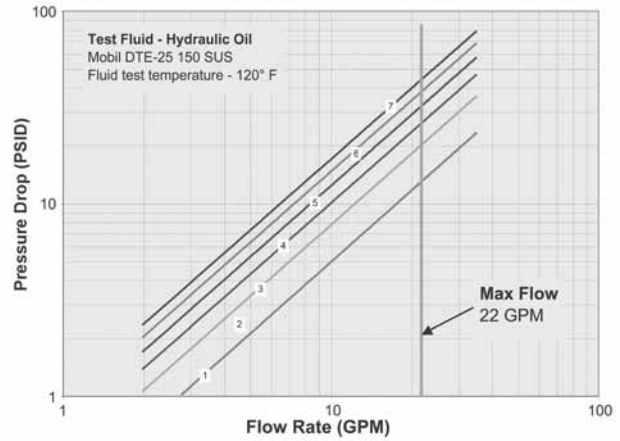

- 480MICRON (1)
- 320MICRON (2)
- 230MICRON (3)
- 165MICRON (4)
- 125MICRON (5)
- 100MICRON (6)
- 065MICRON (7)
- Max Flow

Refer to the General Technical Section for pressure drop data through standard fitting without screen.

Dimensions and pressures for reference only, subject to change.

